



2 MP PIR Siren Full Time Color Camera

User Manual

User Manual

Thank you for purchasing our product. If there are any questions, or requests, do not hesitate to contact the dealer.

This manual applies to the models below:

Type	Model
Type I Camera	DS-2CE12DFT-PIRXOF
	DS-2CE12DFT-PIRXOF28
Type II Camera	DS-2CE72DFT-PIRXOF
	DS-2CE72DFT-PIRXOF28

This manual may contain several technical mistakes or printing errors, and the content is subject to change without notice. The updates will be added to the new version of this manual. We will readily improve or update the products or procedures described in the manual.

01000020201211

Regulatory Information

FCC Information

Please take attention that changes or modification not expressly approved by the party responsible for compliance could void the user's authority to operate the equipment.

FCC compliance: This equipment has been tested and found to comply with the limits for a Class A digital device, pursuant to part 15 of the FCC Rules. These limits are designed to provide reasonable protection against harmful interference when the equipment is operated in a commercial environment. This equipment generates, uses, and can radiate radio frequency energy and, if not installed and used in accordance with the instruction manual, may cause harmful interference to radio communications. Operation of this equipment in a residential area is likely to cause harmful interference in which case the user will be required to correct the interference at his own expense.

FCC Conditions

This device complies with part 15 of the FCC Rules. Operation is subject to the following two conditions:

1. This device may not cause harmful interference.
2. This device must accept any interference received, including interference that may cause undesired operation.

EU Conformity Statement



This product and - if applicable - the supplied accessories too are marked with "CE" and comply therefore with the applicable harmonized European

standards listed under the Low Voltage Directive 2014/35/EU, the EMC Directive 2014/30/EU, the RoHS Directive 2011/65/EU.



2012/19/EU (WEEE directive): Products marked with this symbol cannot be disposed of as unsorted municipal waste in the European Union. For proper recycling, return this product to your local supplier upon the purchase of equivalent new

equipment, or dispose of it at designated collection points. For more information see: www.recyclethis.info.

2006/66/EC (battery directive): This product contains a battery that cannot be disposed of as unsorted municipal waste in the European Union. See the product documentation for specific battery information. The battery is marked with this symbol, which may

include lettering to indicate cadmium (Cd), lead (Pb), or mercury (Hg). For proper recycling, return the battery to your supplier or to a designated collection point. For more information, see: www.recyclethis.info.



Industry Canada ICES-003 Compliance

This device meets the CAN ICES-3 (A)/NMB-3(A) standards requirements.

Warning

This is a class A product. In a domestic environment this product may cause radio interference in which case the user may be required to take adequate measures.

Safety Instruction

Warnings

- In the use of the device, you must be in strict compliance with the electrical safety regulations of the nation and region.
- Input voltage should meet both the SELV (Safety Extra Low Voltage) and the Limited Power Source with 12 VDC according to the IEC60950-1 standard and IEC62368-1 standard. Refer to technical specifications for detailed information.
- Do not connect multiple devices to one power adapter to avoid over-heating or a fire hazard caused by overload.
- The socket-outlet shall be installed near the equipment and shall be easily accessible.
- Make sure that the plug is firmly connected to the power socket.
- A readily accessible disconnect device shall be incorporated external to the equipment.
- An all-pole mains switch shall be incorporated in the electrical installation of the building.
- If smoke, odor or noise rise from the device, turn off the power at once and unplug the power cord, and then contact the service center.
- Never attempt to disassemble the camera by unprofessional personal.

Cautions

- No naked flame sources, such as lighted candles, should be placed on the equipment.
- Install the equipment according to the instructions in this manual.
- To prevent injury, this equipment must be securely attached to the floor/wall in accordance with the installation instructions.
- Do not touch the sharp edges or corners.
- Do not drop the camera or subject it to physical shock.
- Do not touch sensor modules with fingers.
- Do not place the camera in extremely hot, cold (the operating temperature shall be -40°C to 60°C), dusty or damp locations, and do not expose it to high electromagnetic radiation.
- If cleaning is necessary, use clean cloth with a bit of ethanol and wipe it gently.
- Do not aim the camera at the sun or extra bright places.
- The sensor may be burned out by a laser beam, so when any laser equipment is in using, make sure that the surface of sensor will not be exposed to the laser beam.
- Do not expose the device to high electromagnetic radiation or extremely hot, cold, dusty or damp environment.
- To avoid heat accumulation, good ventilation is required for the operating environment.
- Keep the camera away from liquid while in use for non-water-proof device.
- While in delivery, the camera shall be packed in its original packing, or packing of the same texture.

1 Introduction

1.1 Product Features

The main features are as follows:

- High performance CMOS sensor

- OSD menu with configurable parameters
- 24-hour color image
- Smart light
- PIR detection
- Built-in speaker

1.2 Overview

1.2.1 Overview of Type I Camera

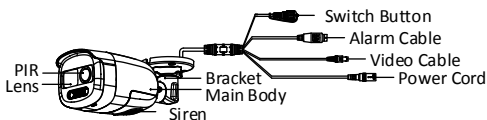

Figure 1-1 Overview of Type I Camera

Note:

Press and hold the switch button for 5 seconds to switch the video output. Four kinds of video outputs are available: TVI, AHD, CVI, and CVBS.

1.2.2 Overview of Type II Camera

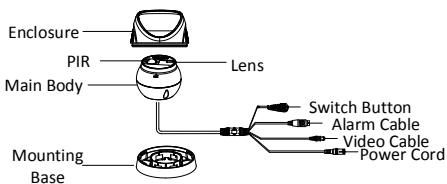

Figure 1-2 Overview of Type II Camera

Note:

Press and hold the switch button for 5 seconds to switch the video output. Four kinds of video outputs are available: TVI, AHD, CVI, and CVBS.

2 Installation

Before you start

- Make sure that the device in the package is in good condition and all the assembly parts are included.
- Make sure that all the related equipment is power-off during the installation.
- Check the specification of the products for the installation environment.
- Check whether the power supply is matched with your power output to avoid the damage.
- Make sure the wall is strong enough to withstand three times the weight of the camera, and the mount.
- If the wall is cement, insert expansion bolts before installing the camera. If the wall is wooden, use self-tapping screws to secure the camera.
- If the product does not function properly, contact your dealer or the nearest service center. DO NOT disassemble the camera for repair or maintenance by yourself.

2.1 Installation of Type I Camera

2.1.1 Ceiling/Wall Mounting without Junction Box

Before you start:

The installation of ceiling mounting and wall mounting are similar. Following takes ceiling mounting as an example.

Steps:

1. Paste the drill template (supplied) to the place where you want to install the camera.
2. Drill the screw holes and the cable hole (optional) on the ceiling according to the drill template.

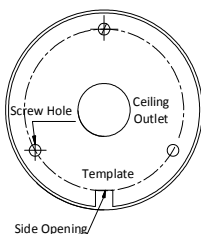

Figure 2-1 Drill Template

Note:

Drill the cable hole, when adopting the ceiling outlet to route the cable.

3. Route the cables through the cable hole or the side opening.
4. Attach the bracket to the ceiling and secure the camera with supplied screws.

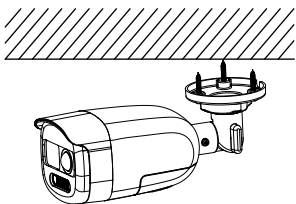

Figure 2-2 Attach the Camera to the Ceiling

Note:

- The supplied screw package contains self-tapping screws, and expansion bolts.
 - For cement wall/ceiling, expansion bolts are required to fix the camera. For wooden wall/ceiling, self-tapping screws are required.
5. Connect the corresponding power cord and video cable.
 6. Power on the camera to check whether the image on the monitor is gotten from the optimum angle. If not, adjust the camera according to the figure below to get an optimum angle.

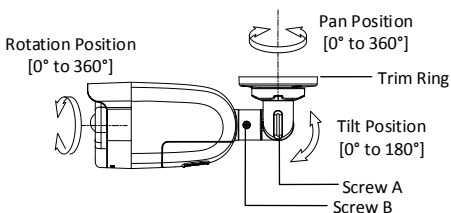

Figure 2-3 3-Axis Adjustment

- 1). Loosen the trim ring to adjust the pan position [0° to 360°].
- 2). Loosen screw A to adjust the tilt position [0° to 180°].
- 3). Loosen screw B to adjust the rotation position [0° to 360°].

2.1.2 Ceiling/Wall Mounting with Junction Box

Before you start:

You need to purchase a junction box in advance.

Steps:

1. Paste the drill template on the ceiling/wall.
2. Drill screw holes and the cable hole on the ceiling according to the drill template.

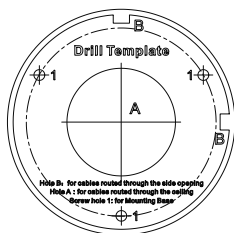

Figure 2-4 Drill Template of Junction Box

3. Take apart the junction box, and align the screw holes of the camera with those on the junction box's cover.
4. Attach the camera on the junction box's cover with supplied screws.

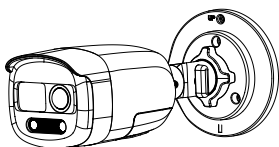

Figure 2-5 Attach the Camera on the Junction Box's Cover

- Secure the junction box's body on the ceiling/wall with supplied screws.

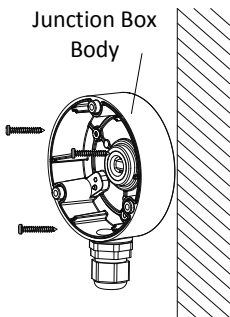

Figure 2-6 Secure the Junction Box on the Wall/Ceiling

- Route the cables through the bottom cable hole or the side cable hole of the junction box.
- Combine the junction box cover with its body.

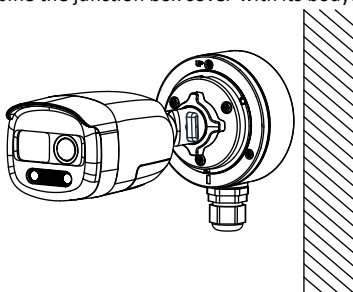

Figure 2-7 Combine the Junction Box Cover with Body

- Repeat the step 5 to 6 of 2.1.1 *Ceiling/Wall Mounting without Junction Box* to finish the installation.

2.2 Installation of Type II Camera

2.2.1 Ceiling/Wall Mounting without Junction Box

Before you start:

The installation of ceiling mounting and wall mounting are similar. Following takes ceiling mounting as an example.

Steps:

- Disassemble the camera by rotating the camera to align the notch to one of the line, as shown in the figure below.

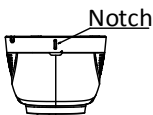

Figure 2-8 Disassemble the Camera

- Pry the mounting base by using a flat object, for example, a coin.

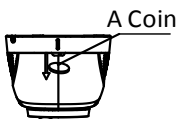

Figure 2-9 Pry the Mounting Base

- Paste the drill template (supplied) to the place where you want to install the camera.

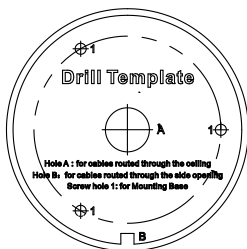

Figure 2-10 Drill Template

Note:

Drill the cable hole, when adopting the ceiling outlet to route the cable.

- Attach the mounting base to the ceiling and secure it with supplied screws. For cement ceiling, you need to install the expansion bolts at first.

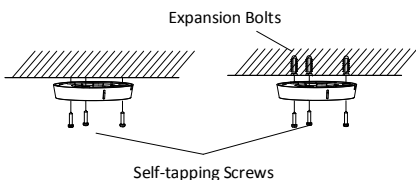

Figure 2-11 Attach the Mounting Base to the Ceiling

Note:

The supplied screw package contains self-tapping screws, and expansion bolts.

- Route the cables through the cable hole, or the side opening.
- Install the camera back to the mounting base and secure it.

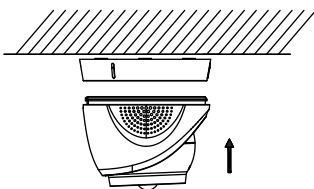

Figure 2-12 Install the Camera Back

- Connect the corresponding cables, such as power cord, and video cable.
- Power on the camera to check whether the image on the monitor is gotten from the optimum angle. If not, adjust the camera according to the figure below to get an optimum angle.

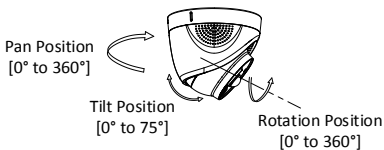

Figure 2-13 3-Axis Adjustment

- 1). Rotate the enclosure to adjust the pan position [0° to 360°].
- 2). Move the camera body up and down to adjust the tilt position [0° to 75°].
- 3). Rotate the main body to adjust the rotation position [0° to 360°].

2.2.2 Ceiling/Wall Mounting with Junction Box

Before you start:

You need to purchase a junction box in advance. The installation of ceiling mounting and wall mounting are similar. Following takes wall mounting as an example.

Steps:

1. Paste the drill template on the wall.
2. Drill screw holes and the cable hole (optional) on the wall according to the drill template.

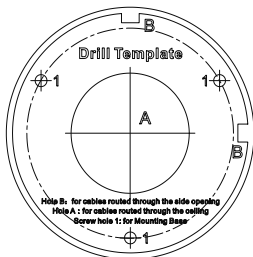

Figure 2-14 Drill Template

Note:

Drill the cable hole, when adopting ceiling outlet to route the cable.

3. Take apart the junction box, and align the screw holes of the mounting base with those on the junction box's cover.
4. Install the mounting base to the junction box's cover with three PM4 screws.

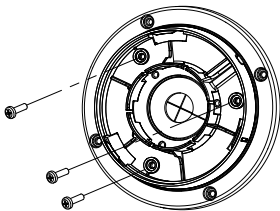

Figure 2-15 Secure screws on the Junction Box's Cover

5. Secure the junction box's body on the wall with four PA4 × 25 screws.

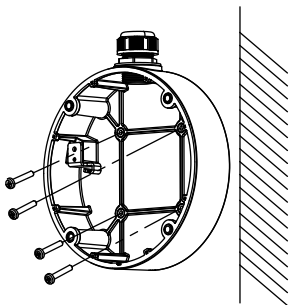

Figure 2-16 Secure the Junction Box's Body

6. Route the cables through the bottom cable hole, or the side cable hole of the junction box.
7. Combine the junction box's cover with its body.
8. Repeat the step 6 to 8 of *2.2.1 Ceiling/Wall Mounting without Junction Box* to finish the installation.

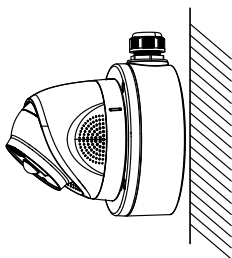

Figure 2-17 Finish the Installation

3 Menu Description

Please follow the steps below to call the menu.

NOTE:

The actual display may vary with your camera model.

Steps:

1. Connect the camera with the TVI DVR, and the monitor, shown as the figure 3-1.

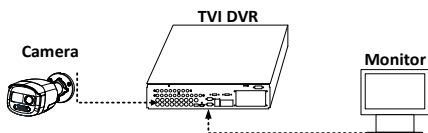



Figure 3-1 Connection

2. Power on the camera, TVI DVR, and the monitor to view the image on the monitor.
3. Click PTZ Control to enter the PTZ Control interface.
4. Call the camera menu by clicking  button, or call the preset No. 95.

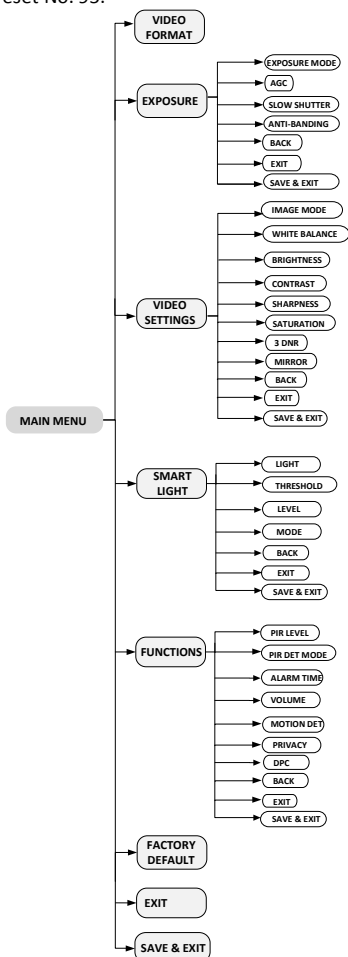

Figure 3-2 Main Menu Overview

5. Click the direction arrow to control the camera.

- 1). Click up/down direction button to select the item.
- 2). Click Iris + to confirm the selection.
- 3). Click left/right direction button to adjust the value of the selected item.

3.1 VIDEO FORMAT

You can set the video format to 2MP@25fps or 2MP@30fps.

3.2 EXPOSURE

EXPOSURE MODE

You can set the **EXPOSURE MODE** to **GLOBAL**, **BLC**, **HLC**, **WDR**, or **HLS**.

- **GLOBAL**

GLOBAL refers to the normal exposure mode which adjusts lighting distribution, variations, and non-standard processing.

- **BLC (Backlight Compensation)**

BLC (Backlight Compensation) compensates light to the object in the front to make it clear, but this may cause the over-exposure of the background where the light is strong.

- **HLC (Highlight Compensation)**

HLC stands for highlight compensation. The camera detects the strong spots (the over-exposure portion of image), then reduce the brightness of the strong spots to improve the overall images.

- **WDR (Wide Dynamic Range)**

The wide dynamic range (**WDR**) function helps the camera provide clear images even under back light circumstances. When there are both very bright and very dark areas simultaneously in the field of view, **WDR** balances the brightness level of the whole image and provide clear images with details.

- **HLS (Highlight Suppression)**

It is the same visual effect as the solar eclipse. If the brightness of a part in the image exceeds the threshold, this part will become black. Then whole image can be clear.

AGC (Auto Gain Control)

It optimizes the clarity of the image in poor light conditions. The **AGC** level can be set to **HIGH**, **MEDIUM**, or **LOW**.

Note:

The noise will be amplified when the **AGC** is on.

SLOW SHUTTER

SLOW SHUTTER increases the exposure time on a single frame, which makes a camera more sensitive to the light so it can produce images even in low lux conditions.

ANTI-BANDING

ANTI-BANDING is a camera setting that prevents the appearance of horizontal lines (banding) when photographing images in the low frequency light and high brightness environments.

3.3 VIDEO SETTINGS

Move the cursor to **VIDEO SETTINGS** and click Iris+ to enter the submenu. **IMAGE MODE**, **WHITE BALANCE**, **BRIGHTNESS**, **CONTRAST**, **SHARPNESS**, **SATURATION**, **3 DNR**, and **MIRROR** are adjustable.

VIDEO SETTINGS	
IMAGE MODE	◀ STD ▶
WHITE BALANCE	↵
BRIGHTNESS	◀ 5 ▶
CONTRAST	◀ 5 ▶
SHARPNESS	◀ 5 ▶
SATURATION	◀ 5 ▶
3DNR	◀ 5 ▶
MIRROR	◀ OFF ▶
BACK	↵
EXIT	↵
SAVE & EXIT	↵

Figure 3-3 VIDEO SETTINGS

IMAGE MODE

IMAGE MODE is used to adjust the image saturation, and you can set it to **STD** (Standard) or **HIGH-SAT** (High Saturation).

WHITE BALANCE

White balance, the white rendition function of the camera, is to adjust the color temperature according to the environment. It can remove unrealistic color casts in the image. You can set **WHITE BALANCE** mode to **AUTO**, or **MANUAL**.

- **AUTO**

Under **AUTO** mode, white balance is being adjusted automatically according to the color temperature of the scene illumination.

- **MANUAL**

You can set the **R-GAIN/B-GAIN** value to adjust the shades of red/blue color of the image.

WHITE BALANCE	
MODE	◀ MANUAL ▶
R-GAIN	◀ 5 ▶
B-GAIN	◀ 5 ▶
BACK	↵
EXIT	↵
SAVE&EXIT	↵

Figure 3-4 MWB MODE

BRIGHTNESS

Brightness refers to the brightness of the image. You can set the brightness value from 1 to 9 to darken or brighten the image. The greater the value is, the brighter the image is.

CONTRAST

This feature enhances the difference in color and light between parts of an image.

SHARPNESS

Sharpness determines the amount of detail an imaging system can reproduce.

SATURATION

Saturation is the proportion of pure chromatic color in the total color sensation. Adjust this feature to change the saturation of the color.

3 DNR (3D DNR)

3 DNR refers to 3D digital noise reduction. Comparing with the general 2D digital noise reduction, the 3D digital noise reduction function processes the noise

between two frames besides processing the noise in one frame. The noise will be much less and the video will be clearer.

MIRROR

OFF, **H**, **V**, and **HV** are selectable for mirror.

OFF: The mirror function is disabled.

H: The image flips 180° horizontally.

V: The image flips 180° vertically.

HV: The image flips 180° both horizontally and vertically.

3.4 SMART LIGHT

Under the **SMART LIGHT** sub-menu, you can set the mode to **OFF** or **AUTO**.

- **OFF**

Set it to **OFF** to give up this function.

- **AUTO**

You can set **THRESHOLD** and **LEVEL** in this section.

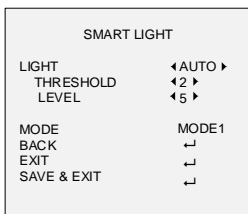

Figure 3-5 SMART LIGHT

3.5 FUNCTIONS

3.5.1 PIR LEVEL

Adjust the sensitivity of the PIR module. The higher the value is, the more sensitive the PIR module is.

Note:

This function is only showed when you switch the video output to TVI mode.

3.5.2 PIR DET MODE

You can set the **PIR DET MODE** to **INDOOR** or **OUTDOOR** to meet your needs.

Note:

This function is only showed when you switch the video output to TVI mode.

3.5.3 ALARM TIME

ALARM TIME refers to the duration of audible and visual alarm.

3.5.4 VOLUME

You can set the volume to **HIGH**, **MEDIUM**, or **LOW**.

3.5.5 MOTION DET

MOTION DET refers to motion detection. With motion detection feature, motion can be detected in any part of a camera's view. You can configure full screen or a number of zones in a camera's view where motion is to be detected.

3.5.6 PRIVACY

This function allows you to block or mask certain area of a scene, for preventing the personal privacy from recording or live viewing. You can turn on/off the **PRIVACY** to meet your needs.

3.5.7 DPC

DPC refers to defective pixel correction. Defective pixels are pixels on a display that are not performing as expected. This function is used to correct pixels like that.

3.6 FACTORY DEFAULT

Reset all the settings to the factory default.

3.7 EXIT

Move the cursor to **EXIT** and click Iris+ to exit the menu.

3.8 SAVE & EXIT

Move the cursor to **SAVE & EXIT** and click Iris+ to save the settings, and exit the menu.