

INSTALLATION MANUAL



PC1000 / PC1000K

This device complies with Parts 15 and 68 of the FCC rules. Operation is subject to the following two conditions: (1) this device may not cause harmful interference, and (2) this device must accept any interference received, including interference that may cause undesired operation.

FCC Reg. No.: F534J3-19591-AL-R
REN = 0.1B Plug Type : RJ31X

MADE IN CANADA

NOTES ON UL INSTALLATION

This equipment is UL listed in accordance with standards UL1023 (Household Burglar - Alarm System Units), UL985 (Household Fire Warning Units), and UL1635 Digital Alarm Communicator System Units.

This equipment has the capability of being programmed for operational features that are not allowed for UL recognized installations. To stay within the standard for household applications, the installer should use the following guidelines when configuring the system.

1. ALL components of the system should be UL listed for the intended application. Note elsewhere in this manual, recommendations for smoke detectors and battery to be used with this equipment.
2. If this system is configured for "Fire", the installer should refer to NFPA Standards #74 for details on locating smoke detectors. When the "Fire" feature is enabled, there must be at least one UL recognized indoor Fire Alarm Warning Signaling Appliance.
3. Maximum allowed entry time = 45 seconds
Maximum allowed exit time = 60 seconds
Minimum allowed bell cutoff time = 4 minutes
4. The installer should caution the user to NOT give system information to casual users. E.g. codes, bypass methods, etc. to baby-sitters or home service people.
5. The installer should advise the user and note in the user manual:
Service organization name and telephone number
The programmed exit time
The programmed entry time

Connection of the fire alarm signal to a fire alarm headquarters or a central station shall be permitted only with the approval of the local authority having jurisdiction.

The burglar alarm signal shall not be connected to a police emergency number.

This manual is for use with both the PC1000 and PC1000K panels. All features and functions are identical except the PC1000K has a keypad mounted on the panel door.

TABLE OF CONTENTS

Specifications

Control Panel Specifications _____	1
Remote Keypad Specifications (PC1000RK) _____	1
Output Voltage Specification _____	1
Digital Communicator Specifications _____	1

Features

Keypad Programming _____	2
Multiple Level Static/Lightning Protection _____	2
"WATCHDOG MONITOR" Circuit _____	2
System Supervision Features _____	2
Advanced Features _____	2

Installation

Bench Testing _____	3
Mounting the Panel _____	3
Hookup Procedure _____	4
Terminal Connections _____	4
Power-up Procedure _____	5
Testing the System _____	5
Instructing End User _____	5

Guidelines for Smoke Detector Location _____ 6

Keypad Functions _____ 7

Introduction _____	7
Master Code _____	7
Installer's Programming Code _____	7
Arming _____	7
Disarming _____	7
Bypassing Zones _____ [*]+[1] _____	8
Trouble Display _____ [*]+[2] _____	8
Alarm Memory _____ [*]+[3] _____	8
Alarm Test _____ [*]+[4] _____	8
User Programming Commands ____ [*]+[5]+[Master Code] _____	8
Quick-arm _____ [*]+[5]+[Master Code]+[5] _____	8
Door Chime _____ [*]+[5]+[Master Code]+[0] _____	8
Special Output Command _____ [*] + [7] _____	9
Installers Programming Commands [*] + [8]+[Installer's Code] _____	9
At-home Arming Command _____ [*] + [9] _____	9
Quick-arm Command _____ [*] + [0] _____	9
Keypad Zones _____	9

Programming Guide

Introduction	10
Installers Programming Commands	10
[1] Phone Number	10
[2] Customer Account Code	10
[3] Alarm Reporting Codes	10
[4] Restoral Reporting Codes	10
[5] Closing/Opening Reporting Codes	11
[6] Other Reporting Codes	11
[7] Zone Definitions and System Options	11
[8] System Times	13
[9] Installer's Code	13
[0] Binary Programming Mode	13
Hexadecimal Programming	13
In Case of Difficulty	14
Accessories and Options	14

Just for the Record	15
----------------------------	----

Notes	16
--------------	----

Programming Work Sheets	17
--------------------------------	----

FCC Compliance Statement	20
---------------------------------	----

Limited Warranty	21
-------------------------	----

Hookup Diagram	22
-----------------------	----

SPECIFICATIONS

Control Panel Specifications

8 zones including:

- 4 fully programmable zones (one zone with EOL resistor option)
- 1 normally open 24 hour zone (audible or silent)/keyswitch zone
- 3 keypad activated zones

Audible alarm output:

- Bell output
600 mA, fused at 5 Amps, 11 VDC unregulated
- Steady or pulsed output

EEPROM memory:

- Does not lose codes or system status on complete AC and battery loss

Programmable output

- 50 mA output
- Operation controllable through program options

Powerful 1.5 Amp regulated power supply:

- 300 mA auxiliary supply, 11 VDC unregulated
- Separately fused for battery, keypad/auxiliary supply and siren/bell output
- Supervision for loss of AC power, low battery

Battery required:

- 12 volt 4 Ah minimum rechargeable gel-cell or sealed lead acid battery

Transformer required:

- 16.5 VAC, 40 VA minimum

Dimensions:

- 8" x 10" x 3" deep (203 x 254 x 76 mm)

Weight:

- 5.5 lbs (2.5 kg)

Remote Keypad Specifications (PC1000RK)

- Four wire (QUAD) hook-up and up to 3 keypads per system
- Built-in piezoelectric sounder
- Full annunciation of zones and system status
- Nominal current draw 40 mA
- Dimensions 4.5" x 4.5" x 1" deep (114 x 114 x 25 mm)
- Alternate keyswitch arming can replace keypad
- Wall plate retainer kit included

Output Voltage Specification

Due to the requirements of standards UL985 and UL1023, it is required to indicate an output voltage of 11 VDC unregulated. Typically, with normal AC in and a fully charged battery, the output voltage will be 13.8 VDC. With AC off and a discharged battery, the voltage will go to 10 volts. Devices that require power from the control panel should be capable of normal operation over the voltage range of 10 to 14 VDC.

Digital Communicator Specifications

- 32 reporting codes
- Transmits all 10BPS and 20BPS formats
- Radionics Rounds and Radionics Parity formats
- 3 or 4 digit customer account code
- 1 or 2 digit alarm code
- Hexadecimal reporting
- Pulse dialing
- DPDT line seizure
- True dial tone detection
- Anti-jam feature
- Digital dialer module can be removed for local alarm installations

FEATURES

Keypad Programming

The PC1000 comes with a default program so it is operational without any initial programming (See programming work sheets at back of manual for default programming). It is completely programmable from the keypad. The panel uses EEPROM memory so that all information is retained even if the panel loses both AC and battery power.

Multiple Level Static/Lightning Protection

The PC1000 has been carefully designed and tested to provide reliable service. It is built to take static and lightning induced surges and keep on working. Multiple level surge filters are on all zone inputs, the power supply, the keypad connections, the siren output, the auxiliary power supply and the telephone interface. A special "ZAP-TRAC" circuit board configuration catches high voltage impulses right at the wiring terminals. Protective ground planes surround sensitive areas preventing the spread of damaging voltage surges. Metal Oxide Varistors (MOV's) are placed in all the critical areas to further reduce impulses to safe levels.

"WATCHDOG MONITOR" Circuit

The PC1000 is equipped with an external "Watchdog Monitor" circuit which continually checks the microprocessor program execution.

System Supervision Features

The PC1000 continuously monitors a number of possible trouble conditions including:

- A loss of the AC power supply.
- Unsuccessful communication attempt.
- A battery supervision circuit that detects a low battery.
- A trouble condition in the supervised loop.
- A test code feature which transmits a communicator test code to the monitoring station at a selected time everyday, every other day or every week.
- A bell/siren test feature which can be activated from the keypad.

Advanced Features

The PC1000 has many advanced features. Features which provide the security system design flexibility and selling advantage necessary to win those demanding jobs and make them profitable.

Some of these features include

- EEPROM memory retains all data even on complete AC and battery.
- Keypad can be used for programming then removed and replaced by a keyswitch arming plate for lower cost installations.
- All programmable zones may be selected as one of 5 different types including; delay, double delay or garage, instant, follower, auto-bypass and 24 hour circuits.
- Keypad programming of up to four access codes.
- Zone bypassing from the keypad.
- Individual zone and system function indicators on keypad.
- A keypad activated utility function for operating lights, door openers, cameras or other devices.

Although the PC1000 has many features, it is not difficult to use. All keypad commands are similar and are assisted by audible and visual cues.

INSTALLATION

Bench Testing

The PC1000 contains a factory default program. Any additional programming required is done through the keypad. For many applications all that will be required is to enter the telephone number and alarm codes with keypad entries that are as straight forward as dialing a telephone number. If you need help talk to your DSC equipment distributor.

Connect a wire jumper across the "A" and "B" terminals for each zone input from 1 to 4. Note that if zone 4 is reprogrammed for a supervised emergency circuit, a 1000 ohm EOL resistor must be connected between terminal "Z4A" and "Z4B". Unless all zone loops are properly terminated the "Ready" light will not be ON and the panel will not arm unless the "Ready" light is ON. (Fail safe arming).

Zones 1, 2, and 3 are high loops. Normally open contacts can be connected between these loops and the negative auxiliary supply (See wiring diagram page 22). Zone 4 is a low loop. If zone 4 is shorted to the auxiliary supply, the auxiliary fuse will be blown.

Connect the four keypad wires to the control panel as shown in the connection diagram page 5.

To completely test the PC1000 including the communicator data, it is necessary to connect the panel to a digital receiver through a telephone line connection or by connecting the telephone terminals on the PC1000 to a digital communicator test set such as the DSC DTS-1. The DSC DTS-1 digital communicator test set is an inexpensive unit which can simulate the telephone system dial tone and the receiver hand shake and kiss-off tones as well as display the data sent out by a digital communicator. Also, the DTS-1 has a "listen-in" feature which makes it ideal for monitoring the transmission between communicator and receiver when the PC1000 is connected to the telephone line.

If you are using a DTS-1, connect the red and green telephone clips to the "TIP" and "RNG" terminals and connect the red and black power clips to the "AUX +" and "AUX -" terminals on the PC1000. When power is applied to the panel press the red local-line button on the DTS-1 and observe the display window area. The "local-line" indicator should be in the local position.

For testing purposes, so that the sound level is not too loud, connect a small buzzer to the "BELL +" and "BELL -" terminals to indicate when the panel is in alarm.

Connect a 16.5 VAC, 40 VA transformer to the "AC" terminals. **Before plugging in the transformer be sure the circuit board is not resting on anything metallic which may cause a short.**

When the transformer is plugged in there should be lights ON on the keypad and the buzzer connected to the bell terminals may go on for a few seconds. If all the zones are jumpered closed all of the zone lights should be OFF.

There are two factory default codes programmed into the system. The factory default Master Code is 1234. The Master

Code is used to arm and disarm the system, program additional codes and perform other system functions. The factory default installer's code is 1000. This code is used by the installer to program the PC1000.

Enter the Master Code to arm or disarm the panel. Note that the panel will arm only if all zones are closed with a jumper so that the "Ready" light is ON. The keypad should beep several times to indicate acceptance of the Master Code. If the keypad is not active check for the presence of AC power at "AC" terminals, check the keypad connections and the panel fuses.

Turn to the "Programming Guide" in this manual and enter a sample program into the panel through the keypad to become familiar with the programming commands.

Program short exit and entry times for faster testing. With the panel disarmed, open each zone by removing the wire jumpers. Observe the zone lights on the keypad go ON for each zone as the jumper is removed. 24 hour zones will cause an alarm. Close all loops so that the "Ready" light comes ON. Enter the arming code. Wait for the exit delay to expire. All lights on the keypad except the "Armed" light will go OFF when the exit delay has expired. Create an alarm on each zone by removing the jumpers. If a DTS-1 is connected to the PC1000, press the dial tone button until the communicator starts to dial. When dialing has stopped press the slow or fast handshake tone button on the DTS-1 for 1 second and then release. Repeat this process until the communication is complete and the line seizure relay drops out. Check the alarm transmissions to confirm that programming is correct. Disarm the panel (system light and zone lights of zones that you activated will be flashing). Press the [#] key to return to "Ready".

If other features such as opening and closing reports are programmed check these transmissions to ensure that the programming is correct. ***NOTE: The closing code, if one is used, is transmitted after the exit delay has expired. This feature is intended to prevent the generation of unwanted signals in the event the user re-enters before the exit delay has expired.***

Mounting the Panel

Select a dry location close to an unswitched AC source, close to a ground connection and close to the telephone connection.

Remove printed circuit board, mounting hardware and keypad from cardboard retainer inside panel. Before attaching cabinet to wall, press the four white nylon mounting studs into cabinet from the back. ***It is important to remember to install mounting studs before mounting cabinet.***

Pull all cables into cabinet and prepare them for connection before mounting the circuit board to the back of the cabinet. Press circuit board down onto mounting studs.

Hookup Procedure

DO NOT connect transformer or battery until all other wiring has been connected. See power-up procedure.

Install keypads and connect wires to keypad terminals on panel.

Connect RJ31-X cord to telephone terminals. Do not insert plug into RJ31-X jack.

Connect bell or siren to "BELL +" and "BELL -" terminals. Observe correct polarity for sirens and polarized bells.

Terminal Connections

AC Power Terminals

Use a 16.5 VAC transformer with a minimum 40 VA rating to supply AC power to the PC1000. The transformer should not be connected to an outlet that is controlled by a switch. If the AC power is turned off a "Trouble" will show on the keypad and if an AC failure code is programmed, an AC trouble transmission will be sent after the programmed delay has expired (See programming section [8]).

Auxiliary Power Terminals "AUX +" and "AUX -"

The auxiliary power supply can be used to power motion detectors and other devices requiring 11VDC. 300mA 11VDC is available from the "AUX +" and "AUX -" terminals when the PC1000 is used with one keypad. For each additional keypad the auxiliary supply rating must be reduced by 40mA. The auxiliary supply is fused with the keypad supply at 1 amp.

Bell/Siren Terminals "BELL +" and "BELL -"

These terminals are for powering bells or other devices requiring a steady output voltage on alarm. The bell output is fused for 5 Amps. When connecting sirens (speakers with built-in siren driver) be sure to observe the correct polarity. Connect the positive lead to the "BELL +" terminal and the negative lead to the "BELL -" terminal.

The bell/siren alarm output is pulsed (1 second ON, 1 second OFF) when an alarm is created by the [1], [3] keypad zone or by zone 4 (when zone 4 is programmed for supervised circuit).

Keypad Terminals "YEL" and "GRN"

Connect the yellow and green wires from the keypad(s) to these terminals. Connect the red keypad wire(s) to "AUX +" and the black keypad wires to "AUX -".

Programmable Output Terminal "PGM"

The operation of the programmable output depends upon which option is selected in the programming table. See the "Programming Guide" section [7] for a list of options for the "PGM" output. The "PGM" output terminal is connected to ground through a normally open transistor switch. A 100 ohm resistor is connected in series to limit the current to a safe operating level when used with the 11 VDC supply. A suitable relay such as the DSC RM-1 may be connected between the 11 VDC "AUX +" terminal and the "PGM" terminal on the main board to operate external devices such as door strikes, etc. See wiring diagram page 22.

Auxiliary Input Terminal "AUX IN"

The "AUX IN" input terminal is a normally open 24 hour zone. It can be programmed from the keypad to be silent or audible. There is no display on the keypad for the "AUX IN" input. An alarm on this input is created by applying a positive voltage or by closing a contact between the "AUX IN" terminal and the positive auxiliary supply ("AUX +"). The auxiliary input is intended to be used as a burglary (Silent Panic Button) or a keyswitch arming terminal.

Zone Input Terminals "Z1A Z1B" to "Z4A Z4B"

These terminals are the loop inputs for four fully programmable zones. Connect normally closed detectors or contacts to each zone. Jumper any unused loops with a wire jumper. To connect devices with normally open contacts (such as floor mats) on zones 1 to 3, connect one wire from the zone to be tripped and the other wire to the negative auxiliary supply terminal ("AUX -"). If a zone will only have normally open contacts connected to it, then a jumper must be installed across the "A" and "B" terminals to close the loop.

Zone 4 may be programmed from the keypad as a supervised end-of-line (EOL) resistor fire circuit. When programmed this way, a contact closure across the EOL resistor will result in a pulse bell/siren. Entering the access code will silence the signal and pressing [*][7] will activate the PGM output and via an RM-1 relay power will be dropped from the smoke detector for about 2 seconds. This action will reset the smoke detector if all smoke is cleared from the chamber (see page 22 for hookup information on using zone 4 as a fire circuit).

NOTE: For UL installations, zone inputs must be terminated with normally closed initiating devices or end of line resistors (1K ohm).

Telephone Terminals "TIP", "RNG", "T-1" and "R-1" (Located on PC1-Dial Module)

The wires from the RJ31-X telephone jack are connected to these terminals in the following way.

TIP	Green wire from RJ31-X cord	▶ Incoming line from telephone company
RNG	Red wire from RJ31-X cord	▶
T-1	Brown wire from RJ31-X cord	▶ Outgoing line to house telephone(s)
R-1	Grey wire from RJ31-X cord	▶

NOTES: Ensure that plugs and jacks meet the dimension, tolerance and metallic plating requirements of 47 C.F.R. Part 68, Subpart F.

For proper operation there must be no other telephone equipment connected between the control panel and the telephone company's facilities.

WARNING: FCC restricts using this equipment on certain types of telephone lines. Read FCC Compliance Statement at the end of this manual. Also, do not use this equipment on a telephone line equipped with a "call holding" feature, as the tone generated may interfere with the communicator operations.

Do not connect the alarm panel communicator to telephone lines intended for use with facsimile (FAX) machines. These lines may incorporate a voice filter which disconnects the line if other than FAX signals are detected, resulting in incomplete transmissions.

Battery Connections

NOTES: Do not connect the battery or the transformer until the wiring is complete. Connect the red battery lead to the positive battery terminal and the black lead to the negative battery terminal. If the connection is made in reverse the battery fuse will blow. Do not connect the battery until AC has been connected to the panel.

NOTE: The battery charging voltage must not be adjusted on UL listed installations.

PC1000RK Keypad Installation

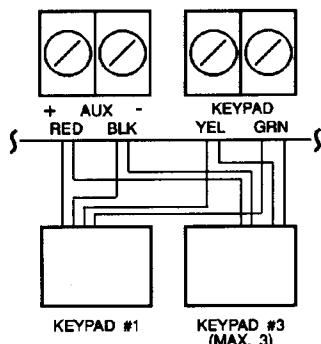

Wiring Chart PC1000RK

Wire Gauge (AWG)	Max. Run Length Keypad to Panel
24	1100' (335m)
22	1770' (540m)
20	2800' (853m)
19	3500' (1067m)
18	4400' (1341m)

NOTES:

1. If the PC1000K is used, keypad on the door, only two remote keypads can be used.
2. Each keypad has four colored leads, Red, Black, Yellow and Green. Connect the leads to the control panel as shown on the above drawing.
3. Up to three keypads can be connected in parallel. Do not connect multiple keypads on the same loop.
4. The wiring table above gives the maximum wire run distances from the control panel to the keypad for various gauges of wire. Wire run distances are calculated based on the maximum current drawn by the keypad. E.g. All lights ON.
5. For standby loading purposes, it is recommended that a current draw of 16 mA per keypad be used. This represents the panel in the disarmed state with two zones in alarm.
6. Referring to the wire table above, if two wires of the same gauge are paralleled, the run length can be doubled. E.g. If 8 #22 AWG wires, 2 Red, 2 Blk, 2 Yel and 2 Grn are run to the keypad, the run length would double from 1770 feet (540m) to 3540 feet (1080m).

Mount the keypads near the exit-entry doors. For flush mounting applications use the wall plate retainer kit that is included with the keypad. For surface mounting applications use the PC1000B back box available from your distributor. The PC1000RK keypad has four wires, coded red, black, green and yellow, which are used to connect it to the panel. Up to three keypads can be connected to one PC1000. Connect all green wires from the keypads to the "GRN" terminal on the panel. Connect all yellow wires to the "YEL" terminal. Connect all red wires to the positive auxiliary supply terminal ("AUX +"). Connect all black wires to the negative auxiliary supply terminal ("AUX -").

Power-up Procedure

If the keypads are located a distance from the panel, install an extra keypad temporarily at the panel during power up testing. An extra keypad with a short length of cable and clips is helpful for testing and programming PC1000 systems. Connect the transformer, wait approx. 5 seconds.

Enter a few keypad commands and open a zone to be sure that the panel and keypad are responding to signals. If the keypad does not respond and there are no indicators on, check for AC voltage at the "AC" terminals. If there is 16 VAC present, check that the keypad wiring is correct and check the keypad/auxiliary supply fuse. If the keypad/auxiliary supply fuse is blown check for a short between the keypad red and black wires before replacing the fuse. If the keypad is responding normally, connect the battery. The red battery lead attaches to the positive battery post and the black battery lead attaches to the negative battery post.

Testing the System

Using the [*][8] command at the keypad, enter short exit and entry times to make testing easier. See "Installers Programming Command", page 9. Arm the panel, wait for the exit delay to expire (**NOTE: All zones have exit delay which allows the user to exit through any convenient door**) then open a door contact or trip a detector. Disarm after each alarm and check alarm memory. Test all contacts and detectors on each zone by opening and closing doors and windows and walking through the path of all motion detectors. If the building is occupied, bypass all zones except the one that is being tested.

After all detectors are checked contact the monitoring station to request a transmission test. Plug the telephone cord into the RJ31-X jack. If a DTS-1 is being used to monitor communicator transmissions, connect as described in "Bench Testing", page 3 and place the DTS-1 in the line mode. Arm the panel, wait for exit delay to expire and trip a detector on an instant circuit. Wait for the communication to complete. Disarm panel and check with the monitoring station to confirm the transmission.

Check the "System" light on the keypad. If it is ON, press [*] then [2] to determine if there is a system trouble. The "Trouble Display" section (page 8) in "Keypad Functions" gives a description of the different trouble conditions. The "System" light is also used to indicate bypassed zones and alarm memory.

Program the exit, entry and alarm cutoff times to the desired values. Program the 24 hour test code transmission time if required. Activate other features being used.

Instructing End User

Fill out the system reference guide in the PC1000 End User's manual. Check off sections in the manual which apply to the user's system and make additional notes if necessary.

Describe the system to an authorized user. Describe arming and disarming procedures. Describe the basic keypad functions. Assist the user in working through examples of each type of command.

Provide the user(s) with the instruction manual and instruct them to read the manual to become familiar with the system operation.

Instruct the user to test the system on a regular basis as described in the user manual. The Master Code should be changed from the default setting and recorded in the End User Manual.

GUIDELINES FOR SMOKE DETECTOR LOCATION

Experience has shown that all hostile fires in family living units generate smoke to a greater or lesser extent. Experiments using typical fires in family living units indicate that detectable quantities of smoke precede detectable levels of heat in most cases. For these reasons, NFPA standard 74 requires smoke detectors to be installed outside of each sleeping area and on each additional story of the family unit.

The following information is for general guidance only and it is recommended that NFPA standard 74 be consulted and that the smoke detector manufacturer's literature be used for detailed installation instructions.

It is recommended that additional smoke detectors beyond those required be installed for increased protection. The added areas include: basement, bedrooms, dining rooms, furnace room, utility room and hallways not protected by the required detectors.

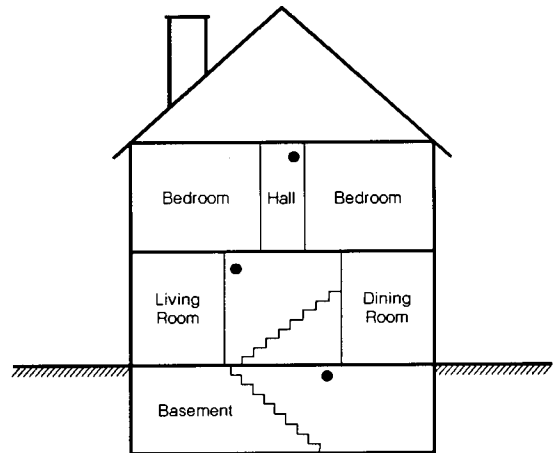

FIG. 3: A smoke detector should be located on each story of the living unit.

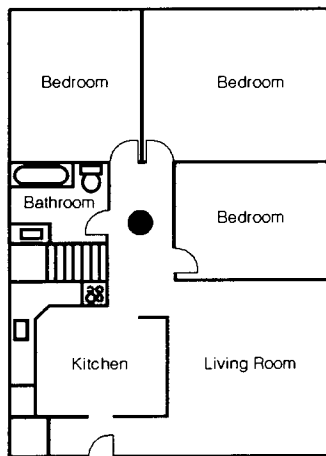

FIG. 1: A smoke detector should be located between the sleeping area and the rest of the family unit.

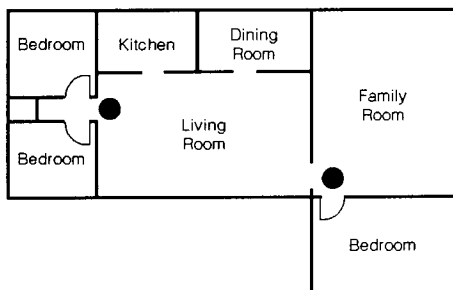
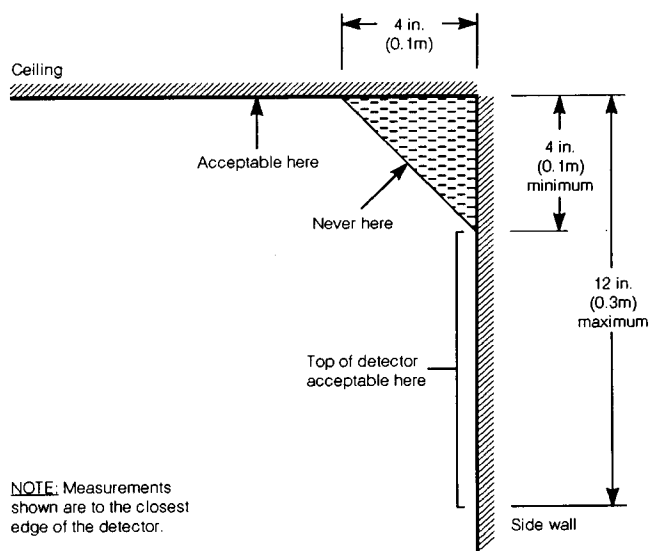

FIG. 2: In the family living units with more than one sleeping area, a smoke detector should be located to protect each sleeping area.



NOTE: Measurements shown are to the closest edge of the detector.

FIG. 4: Smoke Detector mounting - "Dead" Air Space. The smoke from a fire generally rises to the ceiling, spreads out across the ceiling surface and begins to bank down from the ceiling. The corner where the ceiling and wall meet is an air space into which the smoke may have difficulty penetrating. In most fires, this "dead" air space measures about 4 in. (0.1m) along the ceiling from the corner and about 4 in. (0.1m) down the wall as shown in Figure 4. Detectors should not be placed in the "dead" air space.

KEYPAD FUNCTIONS

Introduction

The PC1000RK remote keypad provides complete information and control of the PC1000 control panel. The panel can be fully programmed from the keypad. The 4 zone lights provide alarm and status indication for the alarm circuits. The three function lights guide the user in operating the system and the built-in sounder lets the user hear correct key entries and other alert signals. The 12 digit keypad is used for code entry and other programming functions. All keypad entries are made by pressing one key at a time, with the exception of "Keypad Zone Activation".

The "Ready" light comes ON when all zones are closed. The system can be directed to perform other functions such as zone bypassing, displaying trouble conditions, displaying alarm memory and other programming by entering one of the various commands described below. Pressing the [#] or not making any key entry for two minutes always returns the keypad to the Ready mode.

Master Code

A default Master Code "1234" is factory programmed into the PC1000. The Master Code is used to arm and disarm the panel, to program up to three additional codes and to enable and disable the "Quick-arm" and "Chime" features. The Master Code can be reprogrammed. In the event that you or your customer loses the Master Code, it may be re-entered by using the following procedure:

1. Enter [*][8][Installer's Code]
2. Enter [0] (This enables binary programming)
3. Enter [0][0][1] (This is the address of the Master Code)
4. Enter [1][2], pause, then enter [3][4]
5. Press [#][#] to return to Ready mode

The factory default Master Code will now be restored. Because the PC1000 uses EEPROM memory, the codes and other data are retained even after complete AC and battery failure.

Installer's Programming Code

A default Installer's Programming Code "1000" is programmed into the PC1000. Using this code, the installer can gain access to the system to enter panel program information. This code can be changed by the installer, see section [9]. In the event the Installer's Code is lost or forgotten the panel may be returned to the factory default code by connecting a jumper between the two pins that are located beneath the communicator module and which are marked EEPROM reset. The procedure is as follows:

1. Power down by removing AC and battery
2. Remove communicator module
3. Connect a jumper between the EEPROM reset pins
4. Connect AC or battery
5. Wait for 10 seconds, then remove jumper
6. Power down by removing AC and battery
7. Replace communicator module
8. Connect AC and battery
9. All of the factory default codes will now be loaded into the system

Arming

Before arming the panel, close all protected doors and windows and stop movement in areas covered by motion detectors. Check to see if the "Ready" light is ON (The system can only be armed when the "Ready" light is ON). To arm, enter a 4 digit access code. As each digit is entered, the keypad sounder will beep. When the correct access code has been entered the "Armed" light will come ON and the keypad will beep 3 times. If the access code has been entered incorrectly, the keypad will beep steadily for 2 seconds. Press the [#] key and enter the access code again.

When the correct access code has been entered and the "Armed" light is ON, exit through the designated entry/exit door before the exit delay time expires. At the end of the allowed exit time, all lights on the keypad will go out except the "Armed" light.

Disarming

Enter the premises through the designated entry-exit door. The keypad sounder will be on as a reminder to disarm the system. Go to the keypad and enter the four digit access code. If an error is made entering the code, press the [#] key and enter the code again. The "Armed" light will go out and the sounder will stop. The correct access code must be entered before the entry time expires. If an alarm occurred while the panel was armed, the "System" light and the zone light of the zone which caused the alarm will start to flash and will remain flashing for 2 minutes to indicate to the user that an alarm had occurred. After that the zone light will go out and the "System" light will remain on. To recall memory, see "Alarm Memory" page 8. Pressing the [#] key returns the panel to the Ready mode.

Bypassing Zones

[*]+[1]

A bypassed zone will not cause an alarm. Use zone bypassing when access is needed to part of the protected area. Also, damaged wiring or contacts on a zone may be temporarily bypassed until repairs can be made so that the panel can be armed.

To bypass zones, enter [*][1] and the zone number(s) to be bypassed. Press [#] to return to "Ready". To remove all bypasses, enter [*][0][#]. The zone lights which are ON, while the "System" light is flashing, indicate the bypassed zones.

When the PC1000 is programmed, the ability to bypass certain zones may be eliminated. In this case, the zone lights for those zones will not come on in response to the bypass command. See the "Zone Bypass Mask" instruction in the [*][8] Installer's

Programming section.

The "System" light remains ON as long as any zone is bypassed. Zone bypasses are cancelled each time the panel is disarmed.

Trouble Display

[*]+[2]

The PC1000 continuously monitors a number of possible trouble conditions. If one of these conditions occurs, the keypad "System" light will turn ON. Press the [*], then [2] keys to display the type of trouble. The zone lights indicate the type of trouble condition.

1. Low standby battery
2. AC power failure
3. Zone 4 supervised emergency circuit trouble
4. Unsuccessful communication attempt

Press [#] to return to "Ready".

Alarm Memory

[*]+[3]

The "System" light is turned ON if an alarm has occurred during the previous armed period. The memory will be cleared when the panel is rearmed and the "System" light will go out. Press [#] to return to "Ready".

Alarm Test

[*]+[4]

Press [*][4] for a 2 second test of the keypad lights, keypad sounder and bells/sirens.

User Programming Commands

[*]+[5]+[Master Code]

The [*][5] programming command is used to program additional access codes and to turn on and off the Quick-arm feature and the Chime feature. The factory default Master Code is [1234].

Programming Additional Access Codes

1 Press the [*] and [5] keys and then enter the Master Code which allows access to the additional code programming mode. Zone 1 light will be ON to show that the first code (the Master Code) is already programmed with the factory default (1234). (If Master Code is misplaced or forgotten, see "Master Code" page 7).

2 Three additional codes may be programmed. The zone lights are used to indicate which of these codes are already programmed.

3 To program the second code, press [2] and the zone light will flash. Then enter a 4 digit code and the sounder will beep three times and zone light will come ON steady, indicating a programmed code.

4 To remove an access code, press [2], [3] or [4] corresponding to the code you wish to remove, then enter [*][*][*][*]. The sounder will beep three times and the zone light will go out to show that the code has been removed.

5 Follow the instructions in 3 and 4 for programming or removing any of the other additional codes.

6 Do not try to remove the Master Code (1st code). The Master Code may be changed but it must not be removed. When changing the Master Code, be sure to enter a valid 4 digit number. Do not enter [*] or [#], or the Master Code will not work (See "Master Code", page 7).

7 To program or remove additional codes the panel must be put into the program mode by following step 1 followed by step 3 or 4. Note that if no key entry is made for two minutes the panel will return to the ready mode after which step 1 must be repeated to get back into the program mode.

8 To exit the program mode press [#].

To review:

programming a new code;

enter [*][5][Master Code][1 to 4][4 digit code]

eliminating an existing code;

enter [*][5][Master Code][2 to 4][****].

Quick-arm

[*]+[5]+[Master Code]+[5]

The Quick-arm feature is enabled by entering [*][5][Master Code][5] and accepts [*][0] as a valid arming code. When enabled (enabled 3 beeps.....disabled one long beep) the panel can be armed by entering [*][0]. Press [#] to exit the command. Remember the "Ready" light must be ON to arm.

Door Chime

[*]+[5]+[Master Code]+[0]

The Door Chime feature is enabled or disabled by entering [*][5][Master Code][0]. The keypad will beep three times when enabling and one long beep when disabling. When activated, the keypad buzzer will beep quickly 5 times each time any zone defined as delay or instant circuit opens or closes. The Door Chime feature does not operate on other zone definitions. Zone bypass may be used to eliminate "beeping" on doors where it is not wanted. This feature operates only when the panel is disarmed.

Special Output Command

[*][7]

The programmable output (PGM terminal) on the PC1000 can be programmed to operate by a command from the keypad. This output can be used for operating other devices such as garage door openers, door strikes or line carrier equipment.

The programmable output must be selected for keypad utility function by entering the correct data in the 1st configuration section of the programming worksheet.

Depending on the option chosen in the programming section, the programmable output is activate by pressing the [*][7]. When the keys are pressed, the keypad buzzer and the programmable output are activated for 2 seconds.

Installers Programming Commands

[*][8]+[Installer's Code]

The PC1000 is completely programmed from the keypad by using commands in the [*][8] section. The commands are described in detail in the programming section of this manual. The factory default installer's code is 1000.

At-home Arming Command

[*][9]

Entering [*][9] before the arming code will arm the panel without any entry delay on the delay zones. This command is used for arming the system when protection is desired while the premises are occupied.

Quick-arm Command

[*][0]

Entering [*][0] is accepted as a valid arming code when the Quick-arm feature is activated. This command is often used when individuals are required to arm the system but it is not desired that they be able to disarm the system. See instructions in the "User Programming Commands" section page 8 for activating the Quick-arm feature.

Keypad Zones

There are three zones which can be activated from the keypad.

[1]+[3]

Pressing [1] and [3] keys at the same time activates a fire alarm. The fire alarm sounds the siren/bell in the pulsed mode. The alarm and restoral codes for this zone are programmed using the installers programming command.

[*][#]

Pressing [*] and [#] keys at the same time activates the police (or panic) alarm. The panic alarm may be programmed to be silent or audible (see Zone Definitions and system options, page 11). The alarm and restoral codes are programmed using the installers programming command.

[4]+[6] Keypad Auxiliary Transmission

An auxiliary transmission signal may be sent to the monitoring station by pressing [4] and [6] simultaneously on the keypad. This transmission may be used as another keypad activated zone for service request, late closing request, test transmission or similar purpose. When [4] and [6] are pressed the keypad will beep 3 times and send an alarm and restore transmission. When the alarm transmission is completed, the keypad will beep three times to acknowledge. Note that the alarm and restore codes must be entered in the EEPROM for the transmission to take place. This is done by using the [*][8] Installers Programming command.

PROGRAMMING GUIDE

Introduction

The PC1000 is programmed by entering instructions from the panel keypad. The PC1000 memory is EEPROM and can be reprogrammed thousands of times. The EEPROM will not lose memory, even on total AC and battery loss.

All essential program information required to define the operation of the control panel and the communicator is stored in a section of the EEPROM which can only be accessed by using the Installers Programming Code.

The factory default Installers Programming Code is 1000. This default code can be changed by using one of the commands in this section. If the code is forgotten, you must reset the panel back to factory default (see Installers Programming Code, page 7).

To access the programming commands enter [*][8][Installer's Code]. The "System" light will start to flash and the "Armed" light will come ON steady. The next entry of a number from 0 to 9 determines which section will be programmed. When this section number is entered, the "Ready" light will come on to indicate that the data can now be entered. Most sections contain several groups of two digit entries. The keypad beeps twice after each group of two digits is entered. When the required data is completely entered for the section being programmed, the keypad will beep 5 times and the "Armed" light will come ON to indicate that the data has been entered and another section can be entered for programming. After completing one section, it is not necessary to re-enter the [*][8][Installer's Code] portion of the command. Enter the number of another programming section. When programming a section, it is possible to exit before completing the section by pressing [#]. Only the data entered before pressing [#] will be changed in the EEPROM. Practice entering data in several sections until you become familiar with the programming commands.

Installers Programming Commands

There are 10 sections to the Installers Programming Commands described below. A programming work sheet follows in the next section which is organized in the same order as the descriptions in this section. Fill out the work sheet in pencil, referring to the descriptions in this section as a guide. Remember: To start programming this section, enter [*][8][Installer's Code]; then enter one of the section numbers below. If no entry is made on the keypad for 2 minutes, the panel will go back to the Ready mode.

[1] Phone Number

This is the telephone number to which the communicator will dial. After entering the section number, enter the receiver telephone number the way that you would dial it on a telephone. Up to 15 digits may be entered. Press [#] after the last digit is entered to complete the telephone number programming.

[2] Customer Account Code

After entering the section number, enter a 4 digit number. If a three digit code is required, enter [0] as the last digit of the 4 digit number. If "HEX" digits from "A" to "F" are required, enter [*] which converts the keypad from digital to hexadecimal programming. In this mode, the first 6 keys on the keypad (1 through 6) correspond to HEX numbers "A" to "F". Enter [*] again to return the keypad to digital format.

NOTE: Where a zero is required to be transmitted to the receiver, the "HEX" digit "A" must be used (See HEX data programming note on page 13).

[3] Alarm Reporting Codes

After entering the section number, enter the alarm reporting codes in the following order:

- Zone 1 Alarm
- Zone 2 Alarm
- Zone 3 Alarm
- Zone 4 Alarm
- Panic (Auxiliary Input) Alarm
- Keypad Police [*][#] Alarm
- Keypad Auxiliary [1][3] Alarm
- Keypad Auxiliary [4] and [6] Alarm

Enter a 2 digit alarm reporting code for each item. If a single digit reporting code is desired, enter it followed by a zero, i.e. if alarm code is 3, enter 30. If extended reporting is selected (communication mode is selected in section 7), then enter the first digit as the reporting code and the second digit as the zone extension, that is if 31 is entered as the alarm code and extended reporting is selected in section 7 the transmission would be:

- 123 3
- 333 1 (Assuming a customer account code of 123.)

If a reporting code is not used enter [0][0] in the programming box. When editing codes, only code entries up to the one which is being changed need be entered. Press [#] to exit from the programming sequence. Only codes up to the last one entered will be changed.

[4] Restoral Reporting Codes

After entering the section number, enter the restoral reporting codes in the following order:

- Zone 1 Alarm
- Zone 2 Alarm
- Zone 3 Alarm
- Zone 4 Alarm
- Panic (Auxiliary Input) Alarm
- Keypad Police [*][#] Alarm
- Keypad Auxiliary [1][3] Alarm
- Keypad Auxiliary [4] and [6] Alarm

Enter a restoral reporting code for each item as was done for the alarm reporting codes.

[5] Closing/Opening Reporting Codes

After entering the section number enter the open/close reporting codes in the following order:

- Closing by Access Code 1 (Master Code)
- Closing by Access Code 2
- Closing by Access Code 3
- Closing by Access Code 4
- Opening by Access Code 1 (Master Code)
- Opening by Access Code 2
- Opening by Access Code 3
- Opening by Access Code 4

Enter an open/close reporting code for each item as was done for the alarm reporting codes.

[6] Other Reporting Codes

After entering the section number, enter these reporting codes in the following order:

- Partial Closing Code
- Battery Trouble Alarm
- AC Failure Alarm
- Zone 4 (emergency loop) Trouble Alarm
- Battery Trouble Restore
- AC Failure Restore
- Zone 4 (emergency loop) Trouble Restoral
- 24 Hour Test Code

Enter a code for each item as was done for the alarm reporting codes.

Note that the partial closing code is sent in tandem with the regular closing code to identify it as a partial closing condition ("Partial Closing" denotes the system being armed with one or more zones bypassed.).

NOTE: For UL installations, AC failure or battery trouble reporting must be enabled.

[7] Zone Definitions and System Options

After entering the section number, enter these codes in the following order:

- Zone 1 Definition
- Zone 2 Definition
- Zone 3 Definition
- Zone 4 Definition
- 1st Configuration Code
- 2nd Configuration Code
- Communication Format Option
- Test Code Repeat Time
- Zone Bypass Mask

Zone Definitions for Zones 1 to 4

The operation of each zone is determined by entering two digits in each of the programming spaces. The first digit entered determines whether the zone will be audible or silent and whether it will have fast or slow response time. The second digit determines the zone type.

1st DIGIT

- 0 = Slow, audible
- #1 = Slow, silent
- 2 = Fast, audible
- #3 = Fast, silent

2nd DIGIT

- 0 = Standard delay
- 1 = Instant
- 2 = Interior (Follower)
- 3 = Home-away
- 4 = 24 Hour
- *5 = Double delay

Not allowed for UL Local installations

* The maximum delays allowed for UL installations are:
Entry delay = 45 seconds Exit delay = 60 seconds

The fast response time is 10 ms and the slow response time is 200 ms.

1st Digit

Audible/Silent determines whether an alarm condition will or will not operate a bell/siren.

Slow/Fast provides the correct loop response time for high speed devices such as glass break detectors or slower devices, such as door contacts or motion detectors. The slower response times minimizes the possibility of false alarms and should be used where possible.

2nd Digit

[0] = Delay provides a predetermined delay in the operation of a device (usually a door contact) which is variable from one to 99 seconds. The delay is intended to allow authorized persons to arm and disarm the system without causing a false alarm, and is usually applied to only one door.

[1] = Instant will cause an alarm the instant it is tripped, except during the period included in the exit delay cycle (All loops are inactive during the exit delay cycle.).

[2] = Interior/Follower will prevent any devices connected to it from initiating an alarm during the period when the delay cycle is in effect. When the delay period expires, devices connected to an interior/follower loop will revert to instant operation.

[3] = Interior/Home-away operates the same as an interior loop except that devices connected to it will not become active unless the delay circuit is activated within its predetermined time period. This option has the effect of bypassing interior detection devices automatically if the user wishes to use the protection system while the premises are occupied.

[4] = 24 Hour provides an active input for alarm devices whose operation must be independent of whether the system is armed or disarmed. Hold up or panic switches and temperature supervision switches are examples of devices used on a 24 hour loop.

[5] = Double Delay provides twice the delay time programmed on the delay loop and is a convenience option for users who might wish to use a different point of entry when disarming the system.

1st Configuration Code

1st Digit

The programmable output consists of a terminal on the PC board marked "PGM" which is normally **high** or above ground. This terminal is switched to ground, through a 100 ohm limiting resistor, under the following conditions:

Pre-alert If [1] is programmed into the first digit box of the 1st configuration code the "PGM" terminal will be grounded during the time that the keypad pre-alert warning signal is operating. This can be used with other devices to turn on interior lighting to assist users when entering the premises to disarm the system.

Keypad Utility Output [*][7] If [2] is programmed into the first digit box of the 1st configuration code, the "PGM" terminal will ground for approximately two seconds when the [*] and [7] keys are pressed in sequence. This can be used with suitable devices to operate door strikes, automatic door openers and similar applications.

System Armed Status If a [4] is programmed into the first digit box of the 1st Configuration Code, the "PGM" terminal will go to ground when the system is placed in the armed state. This option enables other devices, such as the DSC CPZ12A annunciator, to be switched into the protection circuit automatically when the system is armed.

Ground Start Programming [8] into the 1st digit box of the 1st Configuration Code grounds the "PGM" terminal for 2 seconds when the communicator seizes the line. This will provide "ground start" operation for networks that require this method. See details on the hookup diagram for connection of ground start systems.

Programming summary:

- 1 = PGM Output = Pre-alert
- 2 = PGM Output = Keypad Utility Output [*][7]
- 4 = PGM Output = System Armed Status
- 8 = PGM Output = Ground Start

2nd Digit

Restoral on Bell Timeout Mode If [2] is entered in the 2nd digit, the PC1000 will transmit a restore code when the bell/siren times out. Zone 4 will be configured as a normally closed loop with no end of line resistor required.

Restoral on Disarm Mode If [4] is entered in the 2nd digit, the PC1000 will transmit a restore code when the system is disarmed. Zone 4 will be configured as a normally closed loop with no end of line resistor required.

If it is necessary to have Zone 4 operate as a supervised zone with an end of line resistor, then enter [A] if a restoral transmission on bell timeout is required and [C] if a restoral transmission on disarming is required. (To program [A] or [C] please refer to the "Hexadecimal Programming" note, page 13.)

Programming summary:

- 2 = Bell Timeout Restoral Zone 4 = N/C no EOL
- 4 = Restoral on Disarm Zone 4 = N/C no EOL
- A = Bell Timeout Restoral Zone 4 = EOL supervised
- C = Restoral on Disarm Zone 4 = EOL supervised

2nd Configuration Code

The 1st Digit is used to select the option of replacing the keypad with a keyswitch or using the keypad only.

- 0 = Replace keypad with keyswitch
- 4 = Keypad only

The 2nd Digit determines if the auxiliary zone input is to be audible or silent and if the keypad panic input [*][#] is to be audible or silent.

- 0 = Auxiliary zone input silent/keypad panic silent
- 2 = Auxiliary zone input audible/keypad panic silent
- 4 = Auxiliary zone input silent/keypad panic audible
- 6 = Auxiliary zone input audible/keypad panic audible

The factory default values are 42 - Keypad only, auxiliary zone input audible/keypad panic silent.

Communicator Format Options

- [00] Silent Knight/Ademco slow, 10 BPS (1400 Hz handshake)
3/1, 4/1 and 4/2 format
- [01] Sescoa, Franklin, DCO, Vertex, Osborne Hoffman, 20 BPS (2300 Hz handshake)
3/1, 4/1 and 4/2 non extended format
- [02] Radionics rounds, (2300 Hz handshake)
3/1, 4/2 non extended format
- [03] Radionics, (2300 Hz handshake)
3/1, 4/2 non extended with parity format
- [10] Silent Knight/Ademco slow, 10 BPS (1400 Hz handshake)
3/1 extended format
- [11] Sescoa, Franklin, DCI, Vertex, Osborne Hoffman, 20 BPS (2300 Hz handshake)
3/1 extended format
- [12] Radionics rounds, (2300 Hz handshake)
3/1 extended format
- [13] Radionics, (2300 Hz handshake)
3/1 extended with parity format

For Radionics receivers that use 1400 Hz handshake, it is necessary to change the data in two locations using binary programming. The procedure is as follows:

- Enter [*][8] and Installer's Code to access programming
- Enter [0] to access binary programming
- Enter [0][7][4] which is the data address that must be changed
- Enter [9][B] followed by [7][D] then press the [#] twice

The factory default for the communicator format options is 01, 20 BPS.

Communications Compatibility

All these communication formats are compatible with the Silent Knight model SK9000 and Ademco model 685 receivers. For UL installations, ensure that the control unit is reporting to one of these receivers.

Test Code Repeat Time

The PC1000 can transmit a test code to the monitoring station at regular intervals. The frequency of the transmissions is determined by the data entered in this location. The first transmission will take place 12 hours after power up and then, depending on the option chosen, repeat every 24 hours later, every 48 hours later or weekly from then on.

For test transmission:

Every 24 hours enter [1][8], 48 hours enter [3][0], 7 days enter [A][8] (See Hexadecimal Programming on this page). The factory default setting is 18 (Once every 24 hours).

NOTE: (Do not program [0][0] in this section.)

Zone Bypass Mask

The zone bypass mask allows the installer to determine which zones can or cannot be bypassed. To bypass, enter:

Value	Zone 1	Zone 2	Zone 3	Zone 4
[0][0]	-	-	-	-
[0][1]	Yes	-	-	-
[0][2]	-	Yes	-	-
[0][3]	Yes	Yes	-	-
[0][4]	-	-	Yes	-
[0][5]	Yes	-	Yes	-
[0][6]	-	Yes	Yes	-
[0][7]	Yes	Yes	Yes	-
[0][8]	-	-	-	Yes
[0][9]	Yes	-	-	Yes
[0][A]	-	Yes	-	Yes
[0][B]	Yes	Yes	-	Yes
[0][C]	-	-	Yes	Yes
[0][D]	Yes	-	Yes	Yes
[0][E]	-	Yes	Yes	Yes
[0][F]	Yes	Yes	Yes	Yes

NOTE: If zone 4 is used for Fire, enter codes [00] to [07] only so that zone 4 cannot be bypassed.

[8] System Times

This section selects the entry delay time, exit delay time, bell cutoff time and AC failure transmission delay time. After entering the section number, enter 2 digits (01 to 99) for each of the four delay times in the order listed below.

- Entry delay time (in seconds)
- Exit delay time (in seconds)
- Bell cutoff time (in minutes)
- AC failure transmission delay time (in minutes)

[9] Installer's Code

This section is used for reprogramming the Installer's Programming Code. Enter four decimal digits. Do not use [*] or [#] as one of the code digits. Once the digits are entered, the code is changed to the new value.

[0] Binary Programming Mode

(Factory use only)

This section is used to program non-standard features with the assistance of factory technical help. The format is as follows:

- Enter 3 digit decimal address (000 to 128)
- Enter 2 digit HEX data
- [#] Exits from binary programming

Hexadecimal Programming

To make use of the full features of the PC1000 and some digital receivers, some programming entries must be made using the HEX numbers 10 to 15. Hexadecimal numbers are entered from the PC1000 keypad by using the [*] key much like the shift-lock key on a typewriter. Press the [*] once to change the keypad for entering HEX numbers and press it again to return to normal number entry. In HEX entry mode,

- the number [1] on the keypad is equivalent to HEX A or 10
- the number [2] to HEX B or 11
- the number [3] to HEX C or 12
- the number [4] to HEX D or 13
- the number [5] to HEX E or 14
- the number [6] to HEX F or 15

Hexadecimal (HEX) numbers are required when it is desired to transmit signals to the monitor receiver that display as either two digit numbers such as "10" or as HEX numbers such as "A". Be sure to press the [*] key again to return to normal number entry after entering HEX numbers. This is the most common error in programming.

Examples of the use of HEX are:

- Customer number: 1 0 3 Programming: 1*1*3
- Customer number: 1 0 0 3 Programming: 1*11*3
- Alarm code: A 3 Programming: *1*3
- Alarm code: 5 0 Programming: 5*1*

Examples of the use of decimal are:

- Customer number: 1 1 3 Programming: 1 1 3 0
- Customer number: 1 2 3 4 Programming: 1 2 3 4
- Alarm code: 3 Programming: 3 0
- Alarm code: 3 1 Programming: 3 1

In Case of Difficulty

- If the Installer's code is lost or many errors are made in programming, restore the factory default program. To restore EEPROM to factory program, see instructions under "Installers Programming Code", page 7. After factory programming is restored, Master Code will be [1][2][3][4], the Installer's code will be [*][8][1][0][0][0] and all other programming will be returned to factory defaults.
- If Master Code is lost, the Installer's code may be used to recover it. Enter [*][8][1][0][0][0] to enter the programming mode. Then enter [0] followed by [0][0][1]. This is the first address of the Master Code. Enter [1][2] followed by [3][4] and press [#] twice to exit the program mode. The Master Code will now be 1, 2, 3, 4 and can be changed to any 4 digits by using the procedure described on page 7.
- If the communicator does not reach the receiver (i.e. correct telephone number is not dialed), check to see that
 - the telephone number has been programmed correctly
 - the number has been terminated with the [#] key
 - zeros, if any, in the telephone number are programmed using the zero key on the keypad.
- If the communicator reaches the receiver successfully but cannot transmit data, check to see that the account number has been programmed correctly. If the account number contains a zero (which is transmitted as ten pulses) it must be programmed with "HEX A" using the hexadecimal numbering system described on page 13.
- If the account number is 3 digits long, the 4th box in section [2] must be filled with a zero.
- If the communicator is programmed incorrectly, the communicator will hang up and redial repeatedly until its programmed number of attempts is reached at which time it will shut down and display a "fail to communicate" trouble condition. The "fail to communicate" will display as a system trouble condition until either the communicator makes a successful transmission to the monitoring receiver, or until the system is powered down then powered up again.
- If a zone programmed as Home-away does not go into alarm, check to see that the delay zone has been tripped after the system has been armed (i.e. during the exit delay).
- If any zone does not display an alarm on test, first ensure that the exit delay has expired as all zones are inactive during the exit delay period.
- If the panel does not arm, ensure that all zones are closed.
- If communicator will not dial out make sure that reporting codes were programmed in sections that you wished transmitted.
- If there are no lights or buzzer on the keypad when it is powered up; check all fuses, check AC output from transformer, check DC output from AUX[+] and AUX [-], and check wiring of keypad.
- If all or some zones cannot be bypassed, check to ensure that correct code is entered into zone bypass mask in section [7].
- If zone 4 and "Ready" light is flashing, an EOL resistor is likely across zone 4 when it has not been programmed as a supervised loop.

Accessories and Options

- PC1000 Control/Communicator, Communicator interface board and keypad.
- PC1000K Control/Communicator, communicator interface board, and keypad mounted in front panel of cabinet.
- PC1000RK Additional PC1000 keypads.
- PC1000ND Control and keypad without communicator interface board.
- PC1000C Control panel only in metal cabinet.
- PC1000D Communicator interface board.
- PC1000B Backplate for surface mounting PC1000 keypad.



JUST FOR THE RECORD

PC1000/PC1000K Version 2.0

Customer _____ County _____

Address _____

_____ Cross Street _____

Phone _____ Installation Date _____

Contact:

#1 Name _____ Phone _____

#2 Name _____ Phone _____

#3 Name _____ Phone _____

Control _____ Version # _____ Account # _____

Receiver Number _____ Installer's Code _____

Zone Type

Protected Area

1 _____

2 _____

3 _____

4 _____

Entry Time _____ Exit Time _____ Bell Cut Off _____

Keypad Zones

[1]+[3] Key ON OFF

[4]+[6] Key ON OFF

[*]+[#] Key ON OFF

Quick-arm ON OFF

Door Chime ON OFF

Installer's Name _____

[7] Zone Definitions and System Options Page 11

NOTE: Enter valid entries only. Enter [1][8] in Test Code Repeat Time.

<u>Default</u>		<u>1st Digit</u>	<u>2nd Digit</u>
[0][0]	Zone 1 Definition	0= Slow, audible	0 = Delay
[0][1]	Zone 2 Definition	1= Slow, silent	1 = Instant
[0][2]	Zone 3 Definition	2= Fast, audible	2 = Instant delay
[0][2]	Zone 4 Definition	3= Fast, silent	3 = Home-away
			4 = 24 Hour
			5 = Double delay
[1][2]	1st Configuration Code	1 = PGM = Pre-alert	2 = Bell = Not supervised
		2 = PGM = [*][7]	4 = Disarm = Not supervised
		4 = PGM = Armed status	A = Bell = Supervised
		8 = PGM = Ground start	C = Disarm = Supervised
[4][2]	2nd Configuration Code	0= Replace keypad with keyswitch	0 = Auxiliary zone silent/ keypad panic silent
		4 = Keypad only	2 = Auxiliary zone audible/ keypad panic silent
			4 = Auxiliary zone silent/ keypad panic audible
			6 = Auxiliary zone audible/ keypad panic audible

[0][1] Communicator Format Options

- [00] Silent Knight/Ademco slow, 10 BPS (1400 Hz handshake), 3/1, 4/1 and 4/2 format
- [01] Sescoa, Franklin, DCO, Vertex, Osborne Hoffman, 20 BPS (2300 Hz handshake), 3/1, 4/1 and 4/2 non extended format
- [02] Radionics rounds, (2300 Hz handshake), 3/1, 4/2 non extended format
- [03] Radionics, (2300 Hz handshake), 3/1, 4/2 non extended with parity format
- [10] Silent Knight/Ademco slow, 10 BPS (1400 Hz handshake), 3/1 extended format
- [11] Sescoa, Franklin, DCI, Vertex, Osborne Hoffman, 20 BPS (2300 Hz handshake), 3/1 extended format
- [12] Radionics rounds, (2300 Hz handshake), 3/1 extended format
- [13] Radionics, (2300 Hz handshake), 3/1 extended with parity format

[1][8] Test Code Repeat Time 18 = 24 hours, 30 = 48 hours, A8 = 1 week

NOTE: 1st transmission will commence 12 hours after power up and then 24 hour, 48 hours or 1 week after, depending on which time you select. (Do not enter [0][0] in this section.)

[0][F] Zone Bypass Mask

To bypass, enter:

<u>Value</u>	<u>Zone 1</u>	<u>Zone 2</u>	<u>Zone 3</u>	<u>Zone 4</u>
[0][0]	-	-	-	-
[0][1]	Yes	-	-	-
[0][2]	-	Yes	-	-
[0][3]	Yes	Yes	-	-
[0][4]	-	-	Yes	-
[0][5]	Yes	-	Yes	-
[0][6]	-	Yes	Yes	-
[0][7]	Yes	Yes	Yes	-
[0][8]	-	-	-	Yes
[0][9]	Yes	-	-	Yes
[0][A]	-	Yes	-	Yes
[0][B]	Yes	Yes	-	Yes
[0][C]	-	-	Yes	Yes
[0][D]	Yes	-	Yes	Yes
[0][E]	-	Yes	Yes	Yes
[0][F]	Yes	Yes	Yes	Yes

[8] System Times Page 13Default

| 3 | 0 | | | Entry Delay Time (In seconds)

NOTE: Do not program 00 in timers.

| 4 | 5 | | | Exit Delay Time (In seconds)

| 0 | 4 | | | Bell Cutoff Time (In minutes)

| 0 | 4 | | | AC Failure Transmission Delay (In minutes)

[9] Installer's Code Page 13Default

| 1 | 0 | 0 | 0 | | |

FCC COMPLIANCE STATEMENT

CAUTION: Changes or modifications not expressly approved by Digital Security Controls Ltd. could void your authority to use this equipment.

This equipment has been tested and found to comply with the limits for a Class B digital device, pursuant to Part 15 of the FCC Rules. These limits are designed to provide reasonable protection against harmful interference in a residential installation. This equipment generates, uses and can radiate radio frequency energy and, if not installed and used in accordance with the instructions, may cause harmful interference to radio communications. However, there is no guarantee that interference will not occur in a particular installation. If this equipment does cause harmful interference to radio or television reception, which can be determined by turning the equipment off and on, the user is encouraged to try to correct the interference by one or more of the following measures:

- Re-orient the receiving antenna.
- Increase the separation between the equipment and receiver.
- Connect the equipment into an outlet on a circuit different from that to which the receiver is connected.
- Consult the dealer or an experienced radio/television technician for help.

The user may find the following booklet prepared by the FCC useful: "How to Identify and Resolve Radio/Television Interference Problems". This booklet is available from the U.S. Government Printing Office, Washington D.C. 20402, Stock # 004-000-00345-4.

Important Information

This equipment complies with Part 68 of the FCC Rules. On the side of this equipment is a label that contains, among other information, the FCC registration number of this equipment.

Notification to Telephone Company

Upon request, the customer shall notify the telephone company of the particular line to which the connection will be made, and provide the FCC registration number and the ringer equivalence of the protective circuit.

FCC Registration Number: F534J3-19591-AL-R

Ringer Equivalence Number: 0.1B

USOC Jack: RJ-31X

Telephone Connection Requirements

Except for the telephone company provided ringers, all connections to the telephone network shall be made through standard plugs and telephone company provided jacks, or equivalent, in such a manner as to allow for easy, immediate disconnection of the terminal equipment. Standard jacks shall

be so arranged that, if the plug connected thereto is withdrawn, no interference to the operation of the equipment at the customer's premises which remains connected to the telephone network shall occur by reason of such withdrawal.

Incidence of Harm

Should terminal equipment or protective circuitry cause harm to the telephone network, the telephone company shall, where practicable, notify the customer that temporary disconnection of service may be required; however, where prior notice is not practicable, the telephone company may temporarily discontinue service if such action is deemed reasonable in the circumstances. In the case of such temporary discontinuance, the telephone company shall promptly notify the customer and will be given the opportunity to correct the situation.

Additional Telephone Company Information

The security control panel must be properly connected to the telephone line with a USOC RJ-31X telephone jack.

The FCC prohibits customer-provided terminal equipment be connected to party lines or to be used in conjunction with coin telephone service. Inter-connect rules may vary from state to state.

Changes in Telephone Company Equipment of Facilities

The telephone company may make changes in its communications facilities, equipment, operations or procedures, where such actions are reasonably required and proper in its business. Should any such changes render the customer's terminal equipment incompatible with the telephone company facilities the customer shall be given adequate notice to the effect modifications to maintain uninterrupted service.

Ringer Equivalence Number (REN)

The REN is useful to determine the quantity of devices that you may connect to your telephone line and still have all of those devices ring when your telephone number is called. In most, but not all areas, the sum of the RENs of all devices connected to one line should not exceed five (5.0). To be certain of the number of devices that you may connect to your line, you may want to contact your local telephone company.

Equipment Maintenance Facility

If you experience trouble with this telephone equipment, please contact the facility indicated below for information on obtaining service or repairs. The telephone company may ask that you disconnect this equipment from the network until the problem has been corrected or until you are sure that the equipment is not malfunctioning.

Digital Security Controls Ltd.
160 Washburn Street
Lockport, NY 14094



LIMITED WARRANTY

Digital Security Controls Ltd. warrants that for a period of twelve months from the date of purchase, the product shall be free of defect in materials and workmanship under normal use, and that in fulfillment of any breach of such warranty, Digital Security Controls Ltd. shall, at its option, repair or replace the defective equipment upon return of the equipment to its repair depot. This warranty applies only to defects in parts and workmanship and not to damage incurred in shipping or handling, or damage due to causes beyond the control of Digital Security Controls Ltd. such as lightning, excessive voltage, mechanical shock, water damage, or damage arising out of abuse, alteration or improper application of the equipment.

The foregoing warranty shall apply only to the original buyer, and is and shall be in lieu of any and all other warranties, whether expressed or implied and of all other obligations or liabilities on the part of Digital Security Controls Ltd. This warranty contains the entire warranty. Digital Security Controls Ltd. neither assumes, nor authorizes any other person purporting to act on its behalf to modify or to change this warranty, nor to assume for it any other warranty or liability concerning this product.

In no event shall Digital Security Controls Ltd. be liable for any direct, indirect or consequential damages, loss of anticipated profits, loss of time or any other losses incurred by the buyer in connection with the purchase, installation or operation or failure of this product.

WARNING: Digital Security Controls Ltd. recommends that the entire system be completely tested on a regular basis. However, despite frequent testing, and due to, but not limited to, criminal tampering or electrical disruption, it is possible for this product to fail to perform as expected.

HOOKUP DIAGRAM

NOTE: Do not replace with higher value fuses than noted below.

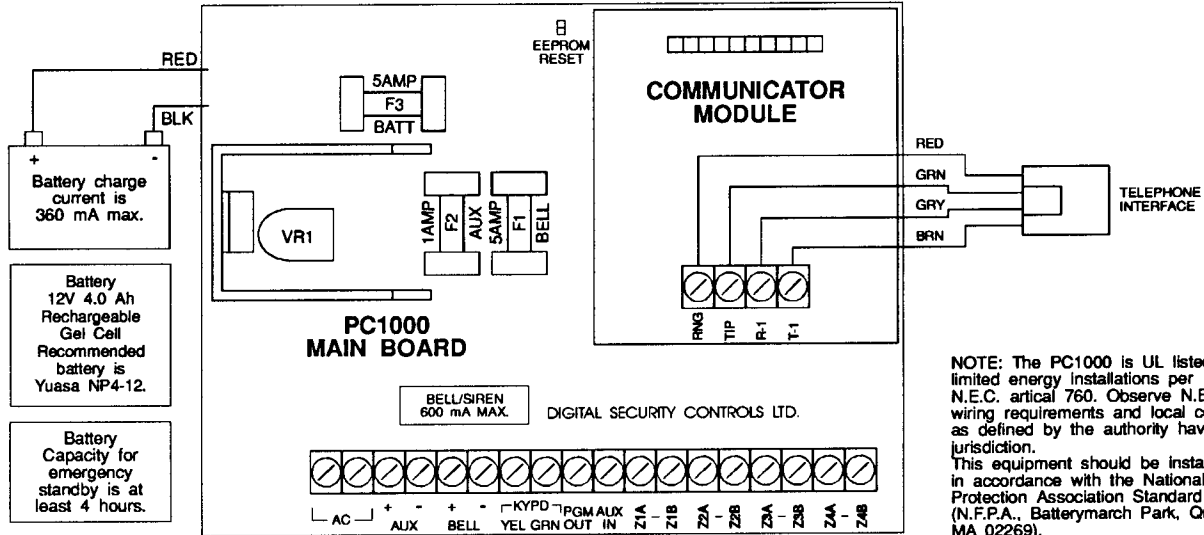

Battery charge current is 360 mA max.

Battery 12V 4.0 Ah Rechargeable Gel Cell Recommended battery is Yuasa NP4-12.

Battery Capacity for emergency standby is at least 4 hours.

WARNING
Incorrect connections may result in blown fuses or improper operation. Check wiring before applying power.

NOTE: Do not connect transformer to a receptacle controlled by a switch. Transformer must be UL listed and have a restraining means. Eg. Basker Electric BE 116240CAA-0002.

NOTE: The PC1000 is UL listed for limited energy installations per N.E.C. artical 760. Observe N.E.C. wiring requirements and local codes as defined by the authority having jurisdiction. This equipment should be installed in accordance with the National Fire Protection Association Standard #74 (N.F.P.A., Batterymarch Park, Quincy MA 02269).

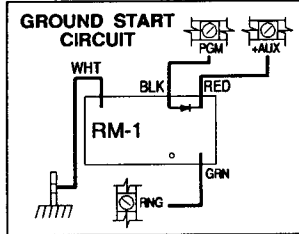

AUX SUPPLY 300 mA MAX. Refer to this manual for detail instructions on keypad wiring. NOTE: All voltage outputs are rated 11 VDC unregulated.

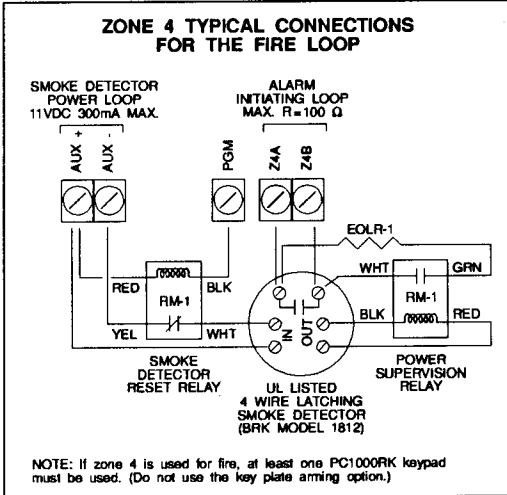
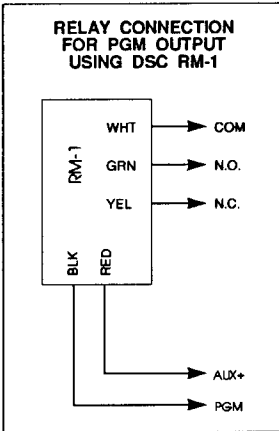
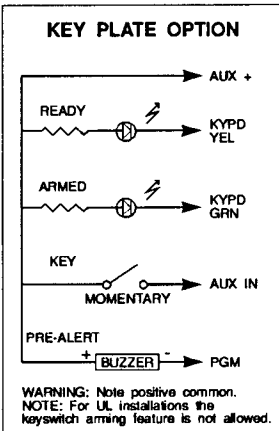

Security detection devices that require power from the control panel must be UL listed for the intended application and operate over the voltage range of 10.0 to 14.0 VDC. DSC model DI-50 and the Bravo series are UL listed.

